

Catalan Exhibitors 2017

Barcelona Industry Week

IOT Solutions World Congress
In(3D)ustry
Blockchain Solutions Forum

Government of Catalonia stand
Barcelona City Council stand

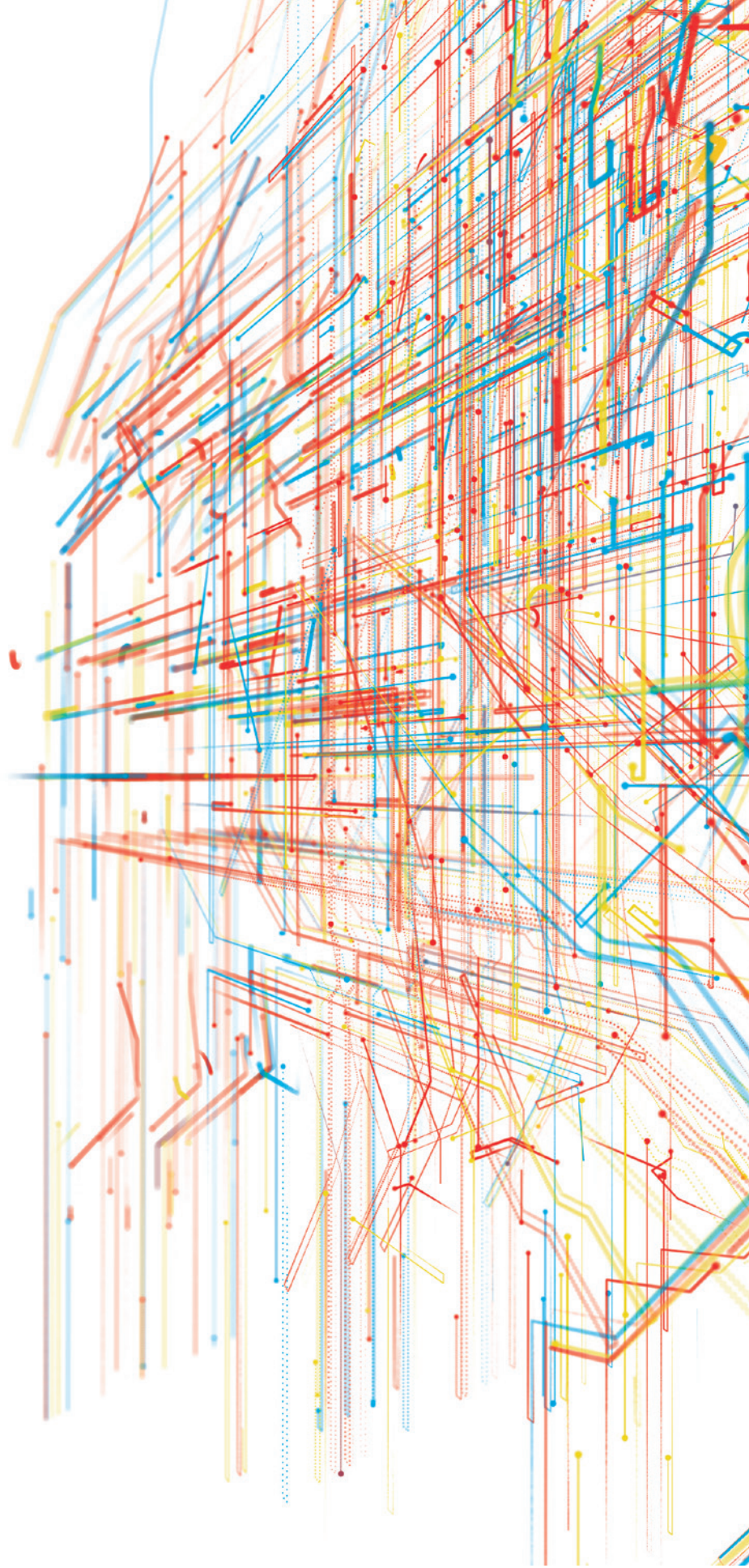

Catalan Exhibitors 2017

Barcelona Industry Week

IOT Solutions World Congress*Exhibitors at the Government of Catalonia stand*

Ackstorm	3
Agrifood AT	3
Ateknea Solutions	3
Beabloo / myBloo	4
Bismart	4
CTTC	4
Datawatt – Seinon	5
Effitronix	5
Eurecat	5
HEMAV	6
i2CAT Foundation	6
IN2	6
Industrial Shields	7
Leitat	7
PickData	7
Sensing & Control	8
SIRT	8
SMILICS	8
Tai Smart Factory	9
Tecsidel	9
UPC Technology Center (CIT UPC)	9

Exhibitors at the Barcelona City Council stand

AEInnova	11
Atlantis IT	11
BitPhy	11
Datalong16	12
EMSER	12
Im3 Solutions	12
inLab FIB UPC	13
Iquadrat	13
NPAW	13
Opentrends	14
Rokubun	14
Smart Data System	14
CIGO! by Sparsity	15
Tandem Company	15
thingtia.cloud	15
vintegrisTECH	16
Zolertia	16

In(3D)ustry*Exhibitors at the Government of Catalonia stand*

3Du Engineering Solutions	19
AIRK Drones	19
Alma Medical Imaging	19
CIMNE	20
Cunicode	20
Eurecat	20
FICEP S3	21
Formbytes	21
GPA Innova	21
IAM 3D Hub Leitat	22
IBEC	22
INTECH3D	22
Integral 3D Printing Experts	23
Lubrizol Advanced Materials	23

Exhibitors at the Barcelona City Council stand

<i>Parc Tecnològic</i>	
CAPTAE	24
DIMO Visual Creatives	24
Ges-Emer	25
SIMBIM	25

Make in Barcelona

Fab Atheneum	26
Aquapioneers	27
Dyibo Barcelona	27
The Things Network	27

Blockchain Solutions Forum*Exhibitors at the Government of Catalonia stand*

Eurecat	30
UbiCrypto	30
Ubiquat	30

IOT Solutions World Congress

Exhibitors at the Government of Catalonia stand

Location in the venue / Hall 5

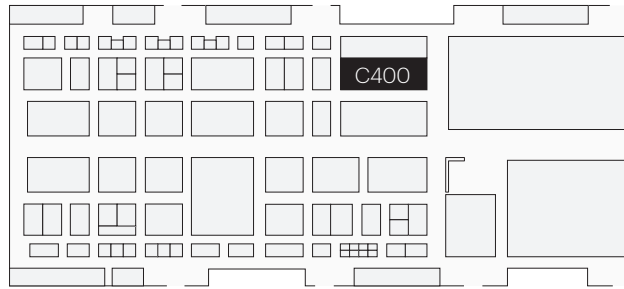

Stand C400

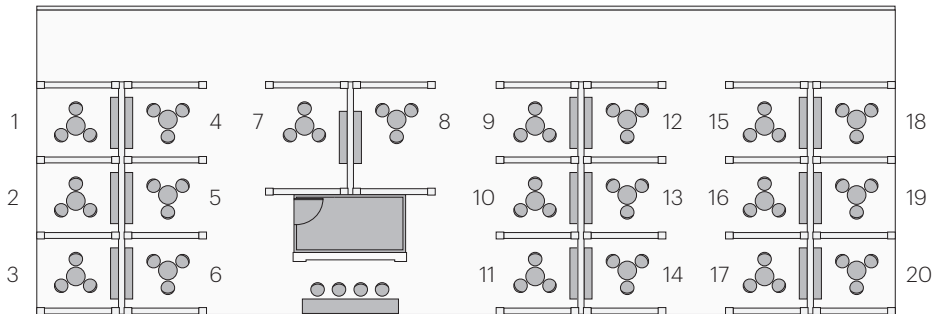

- | | | | |
|----------------------|---------------------|--|------------------------|
| 1. Tecsidel | 7. Eurecat/Leitat | 9. IN2 | 15. Datawatt – Seinon |
| 2. SIRT | 8. i2CAT Foundation | 10. HEMAV | 16. CTTC |
| 3. Tai Smart Factory | | 11. Bismart | 17. Ackstorm |
| 4. Agrifood | | 12. SMILICS | 18. Beabloo |
| 5. PickData | | 13. UPC Technology Center
(CIT UPC) | 19. Ateknea |
| 6. Sensing & Control | | 14. Effitronix | 20. Industrial Shields |

Ackstorm

In ACKSTORM, with over 14 years of experience in Systems Management and Integration, we are experts in Architecture Design, Implementation and 24x7 Management of Cloud Platforms for companies where internet is a critical channel for their business.

Our experience in Cloud Architectures and Systems, together with the development of our Multi-Provider Cloud Management System, facilitates the migration of Online Business to the Cloud, obtaining an improved service, flexibility and scalability in infrastructures, and reducing costs by pay per use.

Government of Catalonia **C400**
Stand 17

Company
Ackstorm

Contact
Gabriel Rivera
gabriel.rivera@ackstorm.com
+34 902 888 345

www.ackstorm.com



Agrifood AT

Agrifood Alternative Technologies has over 17 years' experience providing technological solutions for the feed and animal production industries.

More than 400 companies from Spain, Italy and Portugal are using our solutions on a daily basis. Agrifood AT specialises in the distribution of Cloud Solutions provided by the best partners, as well as solutions developed internally by our own software team. Agrifood AT also possesses great expertise implementing sensor based applications such as: sensorization of silos, smart manure management and GPS vehicle positioning. Our new business strategy based in the IoT is considered today one of our more important activities.

Government of Catalonia **C400**
Stand 4

Company
Agrifood AT

Contact
Jorge Gonzalo
jorge.gonzalo@agrifoodat.com
+34 696 963 364

www.agrifoodat.com



Ateknea Solutions

Ateknea Solutions Europe is a private technology based company operating in Catalunya.

Ateknea offers customized services for innovation with experience in a wide range of scientific and engineering areas, as well as professional support in coordination of projects. Ateknea's operations team offers value-for-money engineering excellence that covers:

- Electronics: Embedded systems, sensor interfacing, energy harvesting circuits, firmware development, custom electronic systems and wireless communications.
- Software: Computer Vision, artificial intelligence, Apps Services, web applications.
- Mechanical design and automation: Mechanical designs and automatization.
- Process systems engineering: Prototyping and industrial automation, Finite Element Method Analysis and Simulation.

Government of Catalonia **C400**
Stand 19

Company
Ateknea Solutions

Contact
Albert Navarro
albert.navarro@ateknea.com
+34 682 609 163

www.ateknea.com



Beabloo / myBloo

Beabloo is a pioneering company in developing online-to-offline (O2O) technologies.

With its headquarters in Barcelona, offices in China and presence in over 20 countries, Beabloo is leader in developing omnichannel digital marketing solutions and Big Data analytics for online and offline.

Beabloo Technology allows brands and organizations to learn about their customer behavior, personalize purchase experiences, create high impact interactions and optimize the use of space to ensure the gain a return on their marketing investments.

Government of Catalonia **C400**
Stand 18

Company
Beabloo / myBloo

Contact
Marta De Celis
marta.decelis@beabloo.com
+34 935 182 207

www.beabloo.com



Bismart

We help decision making by transforming data into knowledge, through Big Data, Data Analytics, Next Generation Dashboards, Scorecards, Key Performance Indicators, Reporting, Datawarehousing and Data Integrations.

Bismart Data Analytics solutions solve the most pressing challenge for any organization, public or private – how to harness the power of the data it gathers every day.

Big Data turns chaos into clockwork. Big Data transforms data into money, it helps companies be more intelligent, more productive, more confident making predictions and helps them make the best decisions. Leading organizations of the future will be distinguished by their predictive algorithms.

Government of Catalonia **C400**
Stand 11

Company
Bismart

Contact
Marta Isern
marta.isern@bismart.com
+34 931 786 880

www.bismart.com



CTTC

The Centre Tecnològic de Telecomunicacions de Catalunya (CTTC) is a non-profit research center and technology institution located in Castelldefels, Barcelona (Spain), and devoted to telecommunication technologies.

CTTC is funded with direct support of the Regional Government of Catalonia and via industrial and publicly funded R&D projects. Founded in 2001, core activities encompass both fundamental and basic research, applied and experimental research, and technology transfer with an international projection. CTTC covers key topics in telecommunications conducting breaking through research.

Government of Catalonia **C400**
Stand 16

Company
Centre Tecnològic de Telecomunicacions de Catalunya (CTTC)

Contact
David Pubill
david.pubill@cttc.cat
+34 936 452 920 (Ext. 2116)

www.cttc.es



Datawatt-Seinon Solutions

DATAWATT is an energy saving tool. We develop software and hardware for energy management and provide solutions to reduce energy costs and CO2 emissions.

We work in 10 countries and we have more than 12.000 locations. Our products allow engineers and energy managers to increase their productivity just with a laptop, tablet or smartphone. Main features of Datawatt/Seinon: Energy and analysis monitoring (Electricity, Natural Gas, Water), alert management, International Performance Measurement and Verification Protocol IPMVP, compatibility with more than 50 manufacturers, automatic and easy report generation, remote control, production control, ISO 50001, integration with BMS and SCADA, benchmarking and real time monitoring.

Effitronix

Effitronix is a company committed to innovation, effectiveness and efficiency, with more than 20 years of experience in industrial automation and predictive maintenance.

Since its beginning, it has offered high value added solutions to clients' needs from multiple industrial sectors.

Back in 2010, Effitronix went ahead of Industry 4.0 trend with the launch of MICO24, a monitoring and control system capable of capturing data from any kind of sensor installed in the key elements of a production plant. MICO24 performs a remote monitoring and transforms these data into useful information in real time to increase productivity and reduce maintenance and energetic costs.

Eurecat

Eurecat is the Technology Centre of Catalonia. We provide industry with differential technology and advanced expertise, to foster innovation and boost companies' competitiveness in a fast-paced environment.

Our services are primarily focused on: applied R&D, innovative technology solutions, highly specialized training, product and service development up to minimum viable products, fablabs and pilot projects and plants.

Eurecat: innovating together with companies. We provide advanced IoT Solutions.

The scope of application is amongst Mobility, Connected Health, E-textiles, Smart Vehicles, Electric cars, Sensors & Big Data, Retail, Energy, Sustainability, Business Transformation, Smart Cities, Industry 4.0 and Drones.

Government of Catalonia **C400**
Stand 15

Company
Datawatt-Seinon Solutions

Contact
Ramon Nicolau
nicolau@aecagroup.com
+34 663 859 197

www.datawatt40.com



Government of Catalonia **C400**
Stand 14

Company
Effitronix

Contact
Lluís Verdaguer
lverdaguer@effitronix.com
+34 938 124 382

www.effitronix.com

effitronix

Innovation in efficiency
and mechatronics

Government of Catalonia **C400**
Stand 7

Company
Eurecat

Contact
Gemma Batlle
gemma.batlle@eurecat.org
+34 608 974 774

www.eurecat.org



HEMAV

HEMAV is a company that designs and commercializes high added-value solutions for industry, combined with its capacity for digital processin and drones, aircraft or satellite Technology.

We specialise in data and image processing and are pioneers in the aeronautical and operative development of drone Technology.

We achieve this with a highly qualified and motivated multidisciplinary engineering team.

Government of Catalonia **C400**
Stand 10

Company
HEMAV

Contact
Neus Figueres
nfigueres@hemav.com
+34 605 503 252

www.hemav.com



i2CAT Foundation

i2CAT Foundation is a research and innovation centre which promotes mission oriented R&D activities on Internet and advanced digital technologies. The centre stands up for a new open innovation framework, fostering the collaboration between companies, public administration, academic environment and end users.

i2CAT has a solid experience in national and European R&D projects, leading research lines in new fixed & mobile network architectures, wireless sensor networks, and content based multimedia technologies.

i2CAT is using this wide expertise to develop new products, services and solutions in Health & Social Care, Smart Cities & Regions, Advanced Manufacturing and Digital Social Innovation for the benefit companies, citizens and public administration. Its aim is converting the territory into a leading global smart region in a Smart Europe, with a flourishing added value economy and an innovative society.

Government of Catalonia **C400**
Stand 8

Company
i2CAT Foundation

Contact
Susana Otero
susana.otero@i2cat.net
+34 605 696 426

www.i2cat.net



IN2

IN2, Ingeniería de la información is an IT company with more than 20 years in the market, expert in the development and implementation of innovative business and technological solutions.

Our philosophy is based on Digital Open Source solutions especially in IoT, Interoperability (Standards, e-Health and Smart Devices), Big Data & Predictive Analysis, Blockchain Security and Mobility.

In summary, we provide our clients with the experience in developing, integrating and implementing solutions aimed at ensuring the security, interoperability and efficiency of their organizations in order to ensure their business objectives.

Government of Catalonia **C400**
Stand 9

Company
IN2

Contact
Xavier Picó
xavier.pico@in2.es
+34 902 881 776

www.in2.es



Industrial Shields

Industrial Shields offers at the industry the safety way to use Open Source hardware.

Our PLCs and panel PCs are based on the most popular open-source developments boards, such as Arduino, Raspberry Pi and Hummingboards, and can be programmed exactly in the same way. This unique characteristic allows engineers to go from prototype to industrialization using the same flexible programming code.

A full automation family of products ready to be used at the Industry 4.0, IoT, monitoring, automation, etc Industrial shields is an international company with presence in more than 65 countries.

Government of Catalonia **C400**
Stand 20



Company
Industrial Shields

Contact
Albert Prieto
apm@industrialshields.com
+34 635 693 611

www.industrialshields.com

LEITAT Technological Center

LEITAT Technological Center covers a wide range in the IoT value chain, from the design and development of sensors/biosensors and smart networks nodes up to data management, going through data protection by means of cybersecurity strategies at software and hardware level.

The design of low-power networks based on energy harvesting strategies for remote applications and predictive maintenance based on cloud solutions offers to our customers flexible solutions for different sectors and applications. Major part of the IoT developments carried out focused on: manufacturing industry (e.g. automotive), environmental sensors, predictive maintenance, buildings and infrastructures.

Keywords: embedded intelligence, sensor/biosensor development, low-power networks, energy harvesting, predictive maintenance.

Government of Catalonia **C400**
Stand 7



Company
LEITAT Technological Center

Contact
Aintzane Arbide
aarbide@leitat.org
+34 937 782 300

www.leitat.org

PickData

Manufacturer of open industrial wired and wireless IoT sensors and software, we provide standard products with standard protocols to integrate with your existing solutions, we design and manufacture customized products, also we provide complete open solutions for integrating with different business models where remote sensing, data monitoring and remote control is required.

Sectors like energy, water, food industry or maintenance are some of the costumers we have today using our solutions and many others are using our services of electronic customized products development and manufacturing.

Energy, food Industry, industrial IoT sensors, building management.

Government of Catalonia **C400**
Stand 5



Company
PickData

Contact
Joan Comellas
jcomellas@pickdata.net
+34 937 362 940

www.pickdata.net

Sensing & Control

We offer IoT solutions to organizations in different sectors including telecom, energy providers, healthcare, buildings construction and management, hardware and appliance manufacturers, retailers, insurance companies and Smart Cities.

Our platform is a complete IoT end-to-end solution that easily integrates with existing communication network, monitoring tool or control systems.

It connects to any device including sensors, actuators, appliances, meters, wearables, smartphones, smart home and building devices (thermostats, lights, energy plugs, air conditioning, heaters, etc.), cameras, locks, etc.

Government of Catalonia **C400**
Stand 6

Company
Sensing & Control

Contact
Pedro Espinel
pedro.espinel@sensingcontrol.com
+34 931 763 520

www.encontrol.io



SIRT

We are a company born in Catalonia on 1998. From the beginning we've always invested heavily on innovation. During all this time we've focused on IT infrastructures and networking solutions.

After all these years of experience in these sectors we decided to take a chance on expanding our capabilities in new technologies and IOT environments with a lot of strength and determination. Nowadays, our main business line is divided in two big sectors:

- IT Infrastructures (i.e. complex networks solutions and datacenters, high-value wireless networks, collaboration tools, fully customized projects, etc).
- IOT (i.e. Infrastructures, integrations, biometric sensors, geolocation, R+D, Innovation, etc).

Government of Catalonia **C400**
Stand 2

Company
SIRT

Contact
David Garriga
david@sirt.com
+34 649 806 649

www.sirt.com



SMILICS

Smilics Technologies is a designer and manufacturer of current sensors and wireless electric meters.

Founded in 1991, SMILICS Technologies produces and assembles in Barcelona.

Government of Catalonia **C400**
Stand 12

Company
SMILICS

Contact
Judit Malgosa
judit.malgosa@smilics.com
+34 935 158 548

www.smilics.com



Taismartfactory

T.A.I., Tecnolgies Aplicadas a la Informaci3n S.L., is a company with 20 years of experience in data processing sector, specialized in development, configuration and maintenance of the capture and management software in real time.

The modular development of the different TAI "Q" products allows to contribute scalable solutions in the environments of the Production, Quality, Industrial Maintenances, Accesses and Personal Presence, integrating in the only speaker all the phases of implantation, connectivity, hardware, databases and necessary adjustments. The knowledge, the availability and the analysis of the real time information, constitutes a great added value for our clients.

Government of Catalonia C400
Stand 3

Company
Taismartfactory

Contact
Antoni Graupera
agraupera@taionline.net
+34 932 981 510

www.taismartfactory.com



Tecsidel

A Tecsidel is a multinational company founded in Barcelona in 1979 and focused on development and integration of Advanced Information Systems.

It is positioned as an international model for Tolling & ITS, Logistics and IT industries.

- Tecsidel Toll systems & ITS is specialized in Multi-Lane Free Flow and turnkey ITS (Intelligent Traffic Systems).
- Tecsidel Logistics systems offers comprehensive solutions to manage warehouses, yards and transport.
- Tecsidel IT Solutions is focused on Digital Transformation and ICT Infrastructures Monitoring, OSS and FSM for Governments, CSPs, and major ICT users.

The company has 300 employees and 3 headquarters in Spain. There are also branches in Brazil, Argentina, Chile, Mexico, Norway and India.

Government of Catalonia C400
Stand 1

Company
Tecsidel

Contact
Ramon Figueras
info.tecsidel@tecsidel.es
+34 932 922 110

www.tecsidel.com



UPC Technology Center (CIT UPC)

The Technology Center of the Universitat Politcnica de Catalunya-Barcelona Tech (CIT UPC) applies university research to innovation in business.

We develop comprehensive, multidisciplinary and turnkey technology solutions and offer companies a wide range of technological capabilities to develop projects in areas like advanced manufacturing technologies, ICT, materials, energy and biomedical engineering technologies. Due to the UPC's excellent research track record in engineering, architecture and science, CIT UPC's knowledge spans a wide technological spectrum. We have strong expertise in IoT technologies such as big data analytics, telecommunications, sensor technologies, mobile health solutions, identity, privacy and security, mobile in smart cities and cloud computing.

Government of Catalonia C400
Stand 13

Company
UPC Technology Center (CIT UPC)

Contact
Laura Peraita
laura.peraita@upc.edu
+34 934 054 403

www.cit.upc.edu



IOT Solutions World Congress

Exhibitors at the Barcelona City Council stand

Location in the venue / Hall 5

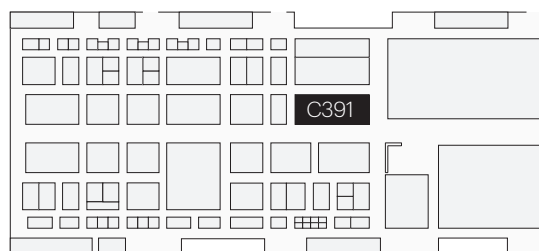

Stand C391

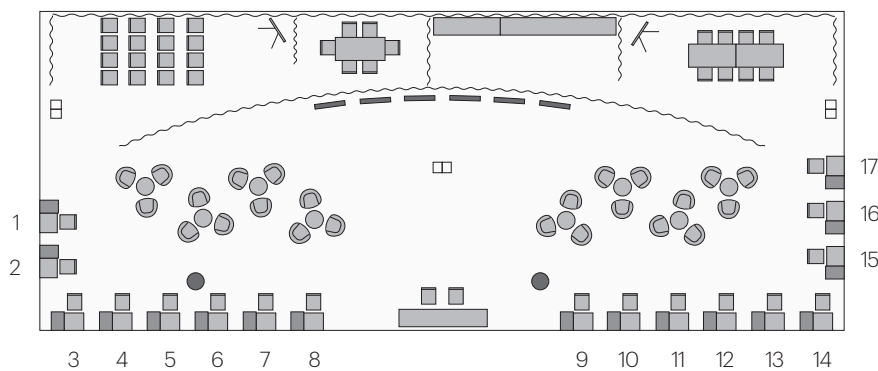

- | | | | |
|-------------------|------------------|----------------------|-----------------------|
| 1. Atlantis IT | 5. Im3 Solutions | 9. Smart Data System | 13. CIGO! by Sparsity |
| 2. Tandem Company | 6. BitPhy | 10. Opentrends | 14. NPAW |
| 3. AEInnova | 7. Rokubun | 11. thingtia.cloud | 15. inLab FIB UPC |
| 4. Datalong16 | 8. Zolertia | 12. EMSER | 16. Iquadrat |
| | | | 17. vintegrisTECH |

AEInnova

AEInnova was founded by 4 Ph.D and 5 engineers in 2014. Europe loses 21% of yearly energy consumption due to industrial waste heat.

AEInnova generates negative carbon energy from this heat thanks to our patent solution based on System-on-chip. It can be returned to electric grid improving the energy efficiency (according to COP21), and power the first battery-less self-powered IOT device in the market (built by AEInnova). Solution is based in space-technology tested in 1970's in Nasa-Propulsion-Lab and installed in NASA Voyager space-crafts.

It is free of maintenance being the perfect and low-cost solution to ensorize ATEX industries (petrochemical, oil&gas, etc).

Barcelona City Council **C391**
Stand 3

Company
AEInnova

Contact
Raúl Aragonés
raul.aragones@aeinnova.com

www.aeinnova.com



Atlantis IT

Because we are passionate to apply technology to solve real problems of people.

Atlantis IT is your partner in efficient management, control and security of your mobile resources (cars, vans, trucks, motorbikes, tractors...) for fleets and particulars.

We make it simple:

- Atlantis Bike : your motorbike connected to you. Security for your bike, and protection for you. Self-managed from your smartphone.
- Atlantis Fleet : We help companies to take decisions to improve their results, their management, control, cost and productivity of their mobile resources.

Barcelona City Council **C391**
Stand 1

Company
Atlantis IT

Contact
Ricard Soler
rsoler@atlantis-technology.com

www.atlantis-technology.com



BitPhy

We have created a solution that supplies a diagnose of the state of any retail business.

We use Machine Learning algorithms in order to give recommendations and prescriptions destined to increase revenues. These algorithms are fed by data coming from the physical shop: point-of-sale billing data and footfall traffic.

BitPhy's customers will have access via any online device to a dashboard containing the most relevant information to their business in order to be able to take better decisions and increase their revenue.

Barcelona City Council **C391**
Stand 6

Company
BitPhy

Contact
Joan Oller
joan@bitphy.com

www.bitphy.com



Datalog16

DataLong16 is a young company founded on the basis of experience in the field of logistics, distribution and management of the cold chain.

In response to the specific demands of our customers and drawing on experience, knowledge and a broad Technical capability we launched the DL16, a small datalogger manufactured In Catalonia and connected with Internet of Things, with high value features for the Industry.

DataLong16 is used in several Vertical industries such as Pharma, Agrifood, Medical, Chemical, Laboratories, Transportation, ... All of them strongly related to logistics and distribution.

Barcelona City Council **C391**
Stand 4

Company
Datalog16

Contact
Griselda Miralles
administracion@datalog16.com

www.datalog16.com



EMSER

The document management platform "GDA" is an integral tool (APP and Web environment) oriented towards field work, which allows inspections, site surveys, As-Built ... removing backoffice works, repetitive tasks and reducing costs.

The main benefits are: easy integration between companies and partners saving management time, analysis and project tracking, audits, quality indicators, executive summaries... EMSER GDA is an innovative tool in engineering sector, creating a work environment totally adapted to the customer needs.

Barcelona City Council **C391**
Stand 12

Company
EMSER

Contact
David Torrejón
dtorrejon@emser.es

www.emser.es



Im3 Solutions

Im3 Solutions is the answer to find a suitable suitable way to solve the needs that our customers face nowadays.

It is impossible to solve today's questions with yesterday's tools and we can not use the same pattern for all challenges.

For that reason we develop customized software proposals which are fully adapted to a specific demand, by relying on technology and innovation.

Barcelona City Council **C391**
Stand 5

Company
Im3 Solutions

Contact
Eva Solà
e.sola@ingenieros-im3.com

www.ingenieros-im3.com



inLab FIB UPC

inLab FIB UPC is a research and innovation laboratory of the Barcelona School of Informatics at Universitat Politècnica de Catalunya, specialized in applications and services based on the latest ICT technologies.

It has over 35 years of experience collaborating in cutting-edge projects, creating customized solutions for public and private institutions and organizations, and providing learning labs specialized in informatics engineering. inLab FIB mission is to transfer knowledge to society by developing humantalent and R&D&i multidisciplinary projects based on the breakthrough ICT technologies, cybersecurity, simulation and data science.

Barcelona City Council **C391**
Stand 15

Company
InLab FIB UPC

Contact
Iwona Maciejewska
Iwona.maryla@fib.upc.edu

inlab.fib.upc.edu/en



Iquadrat

iquadrat Informatica has a focused business plan specifically intended on delivering a “new generation of research tools for system level evaluation of wireless integrated communication systems”.

The company is involved in projects with large corporate clients, mobile operators and public authorities and is currently active in three different domains: Software development, consultancy in wireless network planning, and R&D for developing new and innovative products.

Our R&D department is involved in many EU-funded research projects, and has extensive know-how in IoT Networks, simulation methodologies for Radio Access Networks, Software Defined Networking (SDN) and Demand Response algorithms for the Smart Grid.

Barcelona City Council **C391**
Stand 16

Company
Iquadrat

Contact
David Boixadé
david@iquadrat.com

www.iquadrat.com



NPAW

NPAW is a Business Intelligence and Big Data company helping online media services make strategic decisions across all departments in their company.

Through our solid, scalable analytics infrastructure, we support reliable data analysis for any customer in a timely and cost-effective manner. Our platform, YOBORA Infinity, is a first-in-class product that provides an end-to-end complete suite of integrated video analytics and BI by collecting data from every internet-connected screen. YOBORA Infinity correlates QoE with content and user behavior -before, during and after the video playback, providing video services with descriptive and predictive actionable insights to drive performance and maximize revenue.

Barcelona City Council **C391**
Stand 14

Company
Nice people at work (NPAW)

Contact
Laura Delcor
marketing@nicepeopleatwork.com

nicepeopleatwork.com



Opentrends

Opentrends is the company behind the conception and development of the Sentilo IoT platform, as a result of the collaboration with the Barcelona City Council in the SmartCity area during last 3 years.

Opentrends is a Software Engineering company, based in Barcelona and focused on custom development of specialized APP's, Portals and platforms, like Sentilo, using open source technologies.

Barcelona City Council **C391**
Stand 10



Company
Opentrends

Contact
Carlos Puga
carlos.puga@opentrends.net

www.opentrends.net

Rokubun

Rokubun is a Barcelona-based company focused on low cost accurate and innovative navigation solutions with a vision to democratize accurate positioning.

To reach this goal, we are building a positioning ecosystem ARGONAUT based on a low cost hardware solution aided with a PaaS (Positioning as a Service) cloud platform, that provides our users with accurate navigation solutions. Our ecosystem is specially targeted to the mobile market and, in particular, to Unmanned Aerial Vehicles (UAV), V2X technologies (Vehicle to Infrastructure (V2I) and Vehicle to Vehicle (V2V)), ride area logistics, precision farming and smartphones.

In addition, Rokubun provides R&D services for companies and public institutions in the fields of navigation and positioning as well as earth observation.

Barcelona City Council **C391**
Stand 7



Company
Rokubun

Contact
Xavier Banqué
xavier.banque@rokubun.cat

www.rokubun.cat

Smart Data System

By combining experience from renewable energy consulting projects and expertise developing and comercializing cloud based platforms,

Mycelium Networks offer the Smart Data System IoT enablement platform.

Success stories based on our platform includes solutions for smart buildings, energy management, industrial IoT and more in various private and public sector institutions, including Barcelona city council, other small and medium size cities and towns as well as large supermarket chains and industrial equipment manufacturers.

Barcelona City Council **C391**
Stand 9



Company
Smart Data System

Contact
Adan Salcedo
adan.salcedo@smartdatasystem.es

www.smartdatasystem.es

CIGO! by Sparsity

Sparsity is a spin-off company from UPC-BarcelonaTech specialized in the analysis and management of Big Data and has a long trajectory partnering with strong players like IBM and Oracle, and collaborating in a large number of R&D projects funded by the EU. In 2015 Sparsity was named by the European Commission as the SME with highest innovation capacity.

Sparsity introduces CIGO!, a smart mobility platform to ease the deployment of mobility policies to improve public and private operational efficiency and/or the quality of a product or service to ultimately make an impact on the citizen's duality of life.

Barcelona City Council **C391**
Stand 13

Company
CIGO! by Sparsity

Contact
Josep Lluís Larriba
larri@sparsity-technologies.com

www.smart-cigo.com



Tandem Company

We are a consultancy specializing in strategic creativity and innovation to create new business opportunities.

Experts develop: strategic business transformation routes, lines of innovation and design experiences, products and services. Tandem acts as an innovation ecosystem focused on creating and implementing solutions "out of the box".

Our multidisciplinary team and working methods enable us to tackle projects in any sector.

Barcelona City Council **C391**
Stand 2

Company
Tandem Company

Contact
Rubén Chenovart
r.chenovart@tandem-company.com

www.tandem-company.com



thingtia.cloud

'We crafted it for Barcelona... now we share it in the cloud. thingtia.cloud is a ready-to-use IoT SaaS platform that controls sensors and actuators, based on sentilo@ driven by thingtia solutions, SL, created early 2017, a spin off company of opentrends.

Choose your flexible plan. Change when you need. Try it for free! Flexible freedom of choice. Increasing the platform availability: on SaaS mode, on a private instance or on premise. Support plans - Training plans - Partners network - Certification programs.

Barcelona City Council **C391**
Stand 11

Company
thingtia.cloud

Contact
Paco Robles
paco.robles@thingtia.com

www.thingtia.cloud



vintegrisTECH

vintegrisTECH is a manufacturer of innovative systems and applications for digital certificate management, digital signatures and robust authentication which are used today by banks, insurance companies and leading distributors.

Also established as a Certification Authority, vintegrisTECH provides a global solution to guarantee authentication, privacy and integrity in both the Internet of People and the Internet of Things.

Barcelona City Council **C391**
Stand 17

Company
vintegrisTECH

Contact
Merixell Cot
administracion@vintegris.com

www.vintegris.tech

vintegrisTECH

Zolertia

Zolertia is a hardware and firmware experienced start-up that focuses on the development of IoT products and solutions for corporations and businesses from the Smart City, Industry 4.0 and Logistics markets, making it easy and fast for these companies to design and create the needed electronics to connect their products to the Internet.

This year Zolertia will release a new and powerful Industry solution product, the Antares gateway.

Furthermore, Zolertia provides development platforms for R+D centres, Universities and Tech companies interested in developing IoT projects.

Barcelona City Council **C391**
Stand 8

Company
Zolertia S.L

Contact
Marc Fabregas
mfabregas@zolertia.com

www.zolertia.io



Barcelona is ready to help you landing in the city

For international newcomers

Are you moving to Barcelona?

Barcelona is vibrant and a creative magnet for international talent. A welcoming city that facilitates personal landing and the connection with the local community through:

- Free and complete relocation guides and welcome sessions in English
- Seminars, workshops, expat breakfasts, city business tours
- Afterwork gatherings that put you in touch with the international clubs
- Courses of Catalan for business
- Barcelona International Community Day



Contact us at citypromotion@barcelonactiva.cat

For entrepreneurs

Are you looking to set up your business in Barcelona?

Barcelona Activa provides you with personalised itineraries that will guide you to successfully develop your business activity in Barcelona, a path that will allow you to follow, step by step, the different stages in the entrepreneurial process of starting up a company in Barcelona.

Sign up for a welcome session in English!



Contact us at barcelonactiva.cat/entrepreneurship

For companies

Are you looking to expand your business in Barcelona?

The Business Landing Service provides comprehensive support for Barcelona-based investment projects.

One stop service, free of charge, and fully confidential.

- Information and advice on procedures for setting up in Barcelona
- Online business incorporation service for limited liability companies
- Support for recruitment searches
- Business location searches
- Short-term office space for softlanding
- Information about private suppliers and providers
- Connection with other players in the business ecosystem



Contact us at barcelona.cat/businesslanding



Barcelona
City Council



In(3D)ustry

Exhibitors at the Government of Catalonia stand

Location in the venue / Hall 3



Stand D10

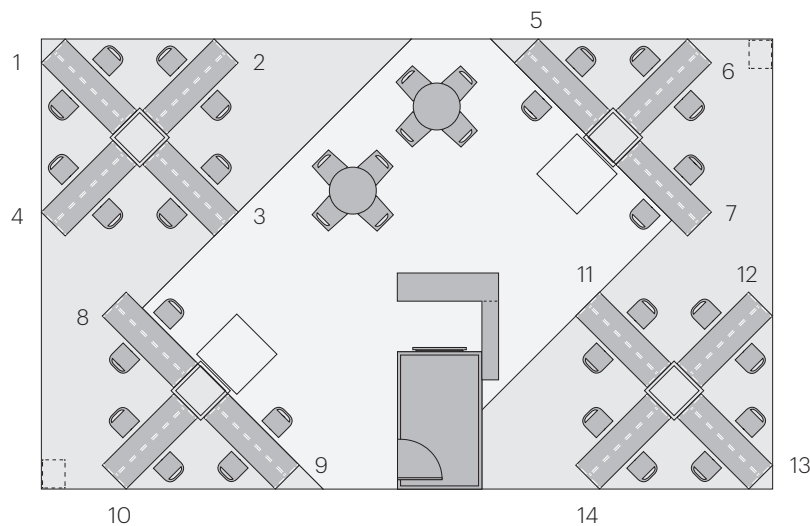

- | | | | |
|----------------|----------------------|-------------------------|---------------|
| 1. FICEP S3 | 5. Intech3d | 8. GPA Innova | 11. 3Du |
| 2. AIRK Drones | 6. Eurecat | 9. Alma Medical Imaging | 12. Formbytes |
| 3. Lubrizol | 7. IAM 3D Hub Leitat | 10. CIMNE | 13. Ibec |
| 4. Integral 3D | | | 14. Cunicode |

3Du Engineering Solutions

3Du Engineering Solutions is a Spanish start-up focused on the optimization of products and processes for the aerospace industry by applying additive manufacturing (AM) or 3D printing technologies.

Their R&D strategy is to develop pioneering applications for AM.

Value is added by the direct benefits obtained with improved products and manufacturing processes and by disrupting the supply chain and transforming the business model of their customers. Services offered are consulting, design&engineering and AM Manufacturing services exclusively to aeronautics and space industry.

Government of Catalonia D10
Stand 11

Company
3Du Engineering Solutions

Contact
Agnes Rosell
agnes@3du-solutions.com
+34 640 119 138

www.3du-solutions.com



AIRK Drones

AIRK is a Spanish technology company headquartered in Barcelona.

It manufactures the most versatile professional unmanned aerial vehicles (UAV), also known as drones.

AIRK is specialized in multicopter drones, having now their first commercial drones family: AIRK FireClouds, a family of highly versatile drones designed for a wide range of applications thanks to the 3D printing accessory system provided on the AIRK Inventor website.

Government of Catalonia D10
Stand 2

Company
AIRK Drones

Contact
David Matanzas
david.matanzas@eurek.es
+34 668 864 248

www.airk.eu



Alma Medical Imaging

Alma Medical Imaging is an IT Spanish company specialized in the development and commercialization of advanced software for medical image analysis and visualization.

Our products for surgical planning include advanced tools, such as 3D reconstruction from MRI and/or CT scans, advanced segmentation of internal organs and 3D Printing.

Government of Catalonia D10
Stand 9

Company
Alma Medical Imaging

Contact
Jordi Lopez
jordi.lopez@alma3d.com
+34 652 372 568

www.alma-medical.com



CIMNE

The International Center for Numerical Methods in Engineering (CIMNE) is a research organization created in 1987 as a partnership between the Government of Catalonia and UPC, in cooperation with UNESCO.

The aim of CIMNE is the development of numerical methods and computational techniques for advancing knowledge and technology in engineering and applied sciences, the education of researchers and the transfer of the research outputs to industry.

CIMNE research aims to breakthroughs on next-generation Numerical Methods and software for the solution of selected multidisciplinary engineering problems of practical interest, and in particular, those problems aligned in the areas of Manufacturing, Transport, Environment and Security.

Government of Catalonia D10
Stand 10

CIMNE[®]



Company
CIMNE

Contact
Cecilia Soriano
csoriano@cimne.upc.edu
+34 934 017 440

www.cimne.com

Cunicode

CUNICODE is a design studio specializing in additive manufacturing and a brand of digitally fabricated products.

With the sponsorship of PROTOPENEDÈS, pioneer Ceramics 3D printing workshop in Catalonia, we present a collection of ceramic pieces 3D Printed with Powder Binding, SLA and Extrusion technologies.

Government of Catalonia D10
Stand 14



Company
Cunicode

Contact
Bernat Cuni
hello@cunicode.com
+34 605 725 905

www.cunicode.com

Eurecat

Eurecat is leader in Catalonia with more than 30 years serving the industry. Advanced Manufacturing Systems (AMS) Unit, in Eurecat, is specialized in Additive Manufacturing (AM) and 3D Printing Manufacturing (3DP).

Our knowledge and Research & Development are focused on developing innovative technologies for AM, in particular Fused Filament Fabrication (FFF), Selective Laser Sintering (SLS), Stereolithography (SLA) and Digital Light Processing (DLP); developing and testing new materials (powders, filaments and resins); creating radical and innovative applications, production processes, and new business models.

Our applied R&D projects, materials and systems are addressed to a more efficient, productive and competitive industry.

Government of Catalonia D10
Stand 6

eurecat
Centre Tecnològic de Catalunya



Company
Eurecat

Contact
Eva Fité
eva.fite@eurecat.org
+34 639 320 461

www.eurecat.org

FICEP S3

FICEP 3D is the part of FICEP S3 dedicated to advanced 3D Manufacturing Services, for both prototyping, medium and mass production runs for Automotive, Aerospace, Industrial or Design Industries, amongst others.

We offer Industrial R+D, Design and Manufacturing services utilizing the latest in 3D technology. We design and build custom parts and machinery in a wide range of applications, all done at the FICEP S3 Technology Center from Vilassar de Dalt.

FICEP S3 also offers Augmented Reality services for industrial applications, which provide a kind user experience for our customers worldwide.

Government of Catalonia D10
Stand 1

Company
FICEP S3

Contact
Dúnia Contreras
d.contreras@ficeps3.com
+34 675 052 135

www.ficeps3.com



Formbytes

In Formbytes we offers 3d printers, our goal is to bring this technology to everyone with an educational environment oriented design, and ideal for initiation.

With a really positive feedback, with several awards is considered the favorite of the teachers. We fill the current large gap of this technology which is the lack of formation and accessibility. Own design made in Barcelona, the main difference apart of the simplicity is that our printer is assembled in a few hours, and successfully tested in public without technical profile, as vast as children, lawyers, retirees and teachers.

Government of Catalonia D10
Stand 12

Company
Formbytes

Contact
Miquel Lloveras
miquel.lloveras@formbytes.com
+34 686 643 999

www.formbytes.com



GPA INNOVA

We initially created Steros GPA Innovative SL in 2013 with the aim of providing solutions in the field of product design and development for industrial applications.

We now specialize in the design and development of machinery for metal finishing. Our first product MURUA represents a machine for the electrolytic grinding of gold, silver & brass jewellery, which allowed us to get revenues of €600k in 2016 within the first year of market launch. Now we are launching the first automatic polishing machine Dlyte for dental prosthetics based on a patent we hold and with potential in other sector as for example additive manufacturing.

Government of Catalonia D10
Stand 8

Company
GPA INNOVA

Contact
Jaume Miras
j.miras@gpainnova.com
+34 677 000 730

www.gpainnova.com



CHROME COBALT DRYLYTE® ELECTROPOLISHING



IAM 3D Hub Leitat

The IAM 3D Hub will provide: Experimenting and testing, End-to-end solutions, Business and mentoring, access to R&D AM/3DP technologies along all the value chain and Education and training.

The IAM 3D Hub mission is to accelerate adoption and development of additive manufacturing and 3D printing technologies in the EU manufacturing sectors as an alternative way to design, develop and manufacture new competitive products and services that strengthens their competitiveness. Our vision is a journey to adoption for SMEs with "one-stop"shop to assess, guide and address all their needs in AM.

Government of Catalonia **D10**
Stand 7

Company
IAM 3D Hub Leitat

Contact
Aintzane Arbide
aarbide@leitat.org
+34 937 882 300

www.iam3dhub.org



IBEC

IBEC is a research centre whose purpose is to carry out interdisciplinary research at the highest international quality level which, by creating knowledge, helps to improve health and quality of life and generate wealth.

Beneficiaries of the Institute for Bioengineering of Catalonia include the scientific community and the business sector that drives research in the bioengineering field, and society in general. IBEC stands at the forefront of advances in health using 3D bioprinting.

By combining its state-of-the-art bioprinter with the decade of know-how of its scientists, the research centre is unique in southern Europe in offering the level of precision and characteristics required for regenerative medicine purposes.

Government of Catalonia **D10**
Stand 13

Company
IBEC (Institut de Bioenginyeria de Catalunya)

Contact
Xavier Rúbies
xrubies@ibecbarcelona.eu
+34 600 314 762

www.ibecbarcelona.eu



INTECH3D

INTECH3D is a 3D printing consulting leader in the region.

We accompany and guide the company in the process of digitalization, advising on the choice of the best technological solutions in hardware, software and materials for 3D printing.

We also prepare their employees and facilities to ensure that the migration process is satisfactory.

MISSION: assist the industry in the introduction of additive manufacturing technology.

Government of Catalonia **D10**
Stand 5

Company
INTECH3D

Contact
Joan Folguera
jfolguera@intech3d.es
+34 681 198 958

www.intech3d.es



Integral 3D Printing Experts

Integral Innovation Experts is a specialized company with extensive experience in the fields of Industry 4.0.

Our goal is to provide solutions that help companies achieve and maintain a competitive advantage in intelligent and connected products and services.

We have four specialized groups: Comprehensive PLM Experts, advanced systems design, analysis and manufacturing (CAD), internet of Things (IoT) 3D Printing Experts specialize in additive manufacturing (3D printing). All these solutions are aimed at increasing the competitiveness of SMEs and large companies at a level of global competition.

We are based in Barcelona (HQ), and we have offices in different cities of Spain.

Government of Catalonia D10
Stand 4

Company
Integral 3D Printing Experts

Contact
Josep Vicenç Garrido
kgarrido@integralplm.com
+34 619 263 987

www.integralplm.com

INTEGRAL
3D PRINTING

Lubrizol Advanced Materials

The Lubrizol Corporation, a Berkshire Hathaway company, is a technology-driven global company that combines specialty chemicals to optimize the quality, performance and value of customers' products while reducing their environmental impact.

Lubrizol is a global market leader with more than 55 years of experience. With a worldwide network that includes formulation design, manufacturing, R&D and cutting-edge technologies, Lubrizol Engineered Polymers offers one of the broadest portfolios of engineered polymers available today including resins that are recyclable*, chemical resistant and fast cycling.

*Recyclability is based on access to a readily available standard recycling program that supports such materials.

Government of Catalonia D10
Stand 3

Company
Lubrizol Advanced Materials

Contact
David Pascual
david.pascual@lubrizol.com
+34 606 383 620

www.lubrizol.com/engineeredpolymers

Lubrizol

In(3D)ustry

Exhibitors at the Barcelona City Council stand

Parc Tecnològic

Location in the venue / Hall 3

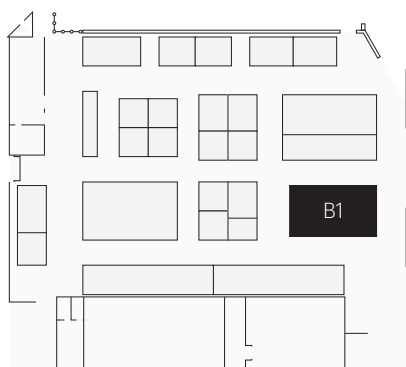

Stand B1

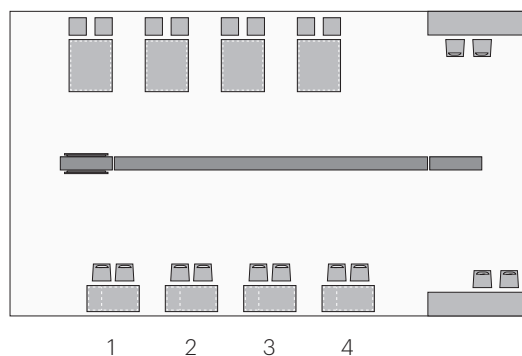

Parc Tecnològic

CAPTAE

CAPTAE delivers 3D Laser Scanner measurement services and has over 8 years' experience in managing 3D point clouds.

It is nowadays an indispensable tool for 3D/BIM modelling of an existing environment or element.

Barcelona City Council B1
Stand 1

Company
CAPTAE

Contact
info@captae

www.captae.com



DIMO Visual Creatives

We are a design & development studio to promote brands, campaigns and digital products.

We help companies and institutions in the consolidation of an attractive and differentiated digital communication adapted to all devices.

We take as a key element the "communication" by designing environments that become brandgenerating assets by themselves, which promote the creation of improvements and positive links experiences between client and company.

Barcelona City Council B1
Stand 2

Company
DIMO Visual Creatives

Contact
info@dimocat

www.dimocat



Ges-Emer

Ges-Emer is a technological company in the field of security and emergencies, creating innovative solutions that respond to the needs of the 21st century market:

- App is a product that become emergency plans in operational documents. The platform feeds on the important information of the plan, allowing emergency teams to send warnings, geolocalize emergencies, equipment, materials, etc., activate automatic actions, confirm their execution, consult the information sheets, perform simulations, receive maintenance notifications, reporting, etc.
- Evacuation3D transforms the static evacuation posters of any installation into 3D audiovisual productions, providing users with more useful, practical and impactful information.
- Professional Virtual Tour allows you to create virtual tours of an installation by adding interactive icons with symbols, signals, documentation, videos or any other searchable file. This facilitates access to the information of any user, even without being in the installation.

Barcelona City Council B1
Stand 3

Company
Ges-Emer

Contact
contacto@ges-emer.com

www.ges-emer.com



SIMBIM

SIMBIM® Solutions is one of the first pioneering and innovative BIM consultancy firms in Spain and delivers high quality consulting services that help companies across AEC industry adopt and realize value from BIM technology.

BIM (Building Information Model) is a digital representation of real building elements in an integrated way, which all 3D digital information of building elements can be extracted and projected into machine languages (3D Printers). This process enables us to print any building elements directly from BIM model in any possible scale by 3D printer with highest possible accuracy, where printing the 1:1 real structure of a building is not far from reality! Then, BIM solutions can be part Additive and Advanced Manufacturing process (such as 3D Printing) in AEC industry.

SIMBIM® Solutions offers a comprehensive set of professional BIM services derived from extensive product knowledge and broad industry expertise. SIMBIM's support-driven business is empowered by an innovative and smart team of highly skilled BIM consultants to promote a real sense of OPEN-BIM implementation into industry.

Barcelona City Council B1
Stand 4

Company
SIMBIM

Contact
info@simbim.es

www.simbim.es



Make in Barcelona

Stand B1

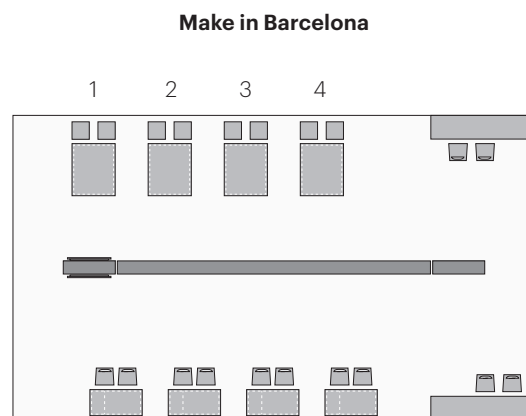

Ateneus de Fabricació Fab Atheneum

Ateneus de Fabricació (or Fab Atheneum) are a public service that explain the technology and science of digital fabrication to help people learn, work and collaborate in order to turn ideas into reality while transforming their environment and contributing to social development.

The aim of Barcelona's Fab Atheneum is to deploy and transversally coordinate a "bottom-up" strategic citizen-participation project in the city's neighbourhoods and districts, based on the precepts of social innovation and the collaborative economy.

The Fab Lab programmes are aimed at fostering and promoting the general public's social innovation, i.e. that it is local residents who are able to enjoy open public areas, tools and resources in order to network and propose projects that improve their immediate surroundings. City's schools, families and innovative people are the main groups that should enjoy places where they can learn, receive training and develop their talent.

At present, there are Fab Atheneum in Les Corts, Ciutat Meridiana and the Fàbrica del Sol (in Barceloneta). The Fab Atheneum in the Technology Park and Gràcia will open shortly. You can visit the Fab Lab network website to get information about activities, projects, programmes, communities, prototypes and machinery.

Barcelona City Council **B1**
Stand 1

Company
Ateneus de Fabricació

Contact
Jordi Reynés / Nuria Martínez-Vernis
jreynes@bcn.cat /
nuriaateneus@gmail.com

ateneusdefabricacio.barcelona.cat



Aquapioneers

It's not magic, it's Aquaponics !

By combining an aquarium and a garden using digital fabrication, Aquapioneers has created a compact and efficient Aquaponics garden.

It allows you to grow your favourite herbs all year round @home @work and even @school, right in the middle of the city.

Barcelona City Council B1
Stand 3

Company
Aquapioneers

Contact
Guillaume Teysié
guillaume@aquapioneers.io

www.aquapioneers.io



Dyibo Barcelona

An Ecotron is a device capable of generating a range of physical and chemical conditions applied to terrestrial or aquatic ecosystems.

Its principle is to confine a biological system (natural or artificial, complex or simplified one) in a enclosure sealed in matter but not in energy, and simultaneously measure and control such flows of matter and energy.

For this purpose, the enclosures are equipped with many sensors to obtain precise real-time measurements and different actuators to control and modify the enclosure environmental conditions.

The idea is to end up with a generic uCosm/bioreactor/ fermentor with a modular design that allows to be adapted by the user to match the specific farming/ culturing/fermenting requirements of the chosen biological specie.

Barcelona City Council B1
Stand 4

Company
Dyibo Barcelona

Contact
Esteban Martin
info@diybcn.org

www.diybcn.org



The Things Network

The Things Network is an Internet data network that is open, global and collectively constructed by local communities. In Barcelona we are working to cover the entire city and surroundings with LoRa data connectivity with free access (Long Range).

LoRa has the potential to enable an entire new class of use cases for the Internet of Things. And the best way to do it, is to build the network ourselves in an open, shared manner.

We work together as a community including social movements, businesses, public institutions, educational and research centres and domestic users. Each one of us benefits from a commons-based network, that we build and control collectively.

Barcelona City Council B1
Stand 2

Company
The Things Network

Contact
Wouter Tebbens
wouter@freeknowledge.eu

www.thethingsnetwork.cat





We make the connections, you build your business

CataloniaConnects

Catalonia, with Barcelona as its capital, is Europe's most trusted Internet of Things hub. It is opening up new ground in smart industry and robotics, as well as creating a highly active production ecosystem for smart cars, smart cities, big data and ICT.

Locate your business in Catalonia and you'll be jumping right into a vibrant city with a dynamic and expert environment of companies, suppliers, tech centres and talent.

With over 30 years' experience and tailor-made services, **Catalonia Trade & Investment** is your ideal partner to connect and build your business with everything you need to make it grow.

catalonia.com



Catalonia Trade & Investment

 **Generalitat de Catalunya**
Government of Catalonia

IoT Catalan Alliance



The **IoT Catalan Alliance** is an initiative promoted within the Smart Catalonia strategies in order to identify the agents of the **IoT** value chain in Catalunya, giving visibility to its members and generating new business opportunities around the Internet of Things. It has around 85 members, including companies, research centers, and associates that develop and implement technological solutions in **IoT**.

Our main objectives are:

- Provide visibility and business opportunities to the alliance members
- Promote the adoption of **IoT** technologies in the industry sectors
- Work on behalf of the Administration in standardization institutions
- Encourage national and international synergies
- Be part of every main **IoT** event

Are you a company, research center or institution based in Catalonia? Do you want to be updated with all the **IoT** news, events and projects in Catalonia and abroad? Do you want to be part of an association that helps you to be part of business opportunities?

Currently, being a member of the **IoT Catalan Alliance** has no associated cost and the main requirements are: being an active member by participating in workshops, trying to identify and create synergies with other stakeholders, and contributing with use cases and news for the **IoT Catalan Alliance** website and its social media.

Blockchain Solutions Forum

Exhibitors at the Government of Catalonia stand

Location in the venue / Entrance Hall 4 - 5

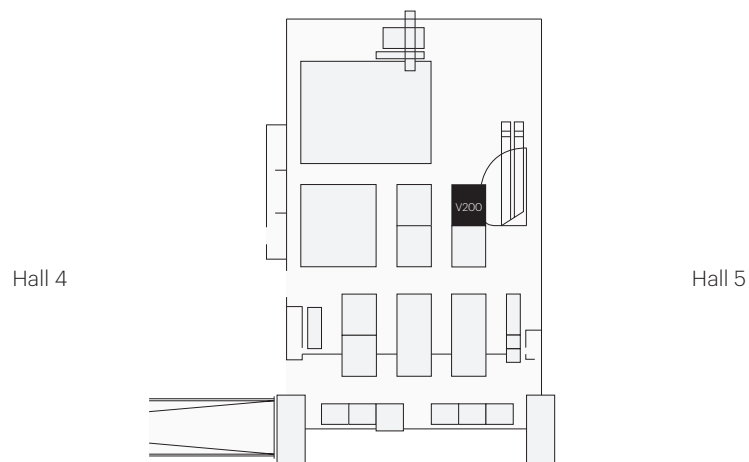

Stand V200

- 1. Ubiquat
- 2. Eurecat
- 3. UbiCrypto

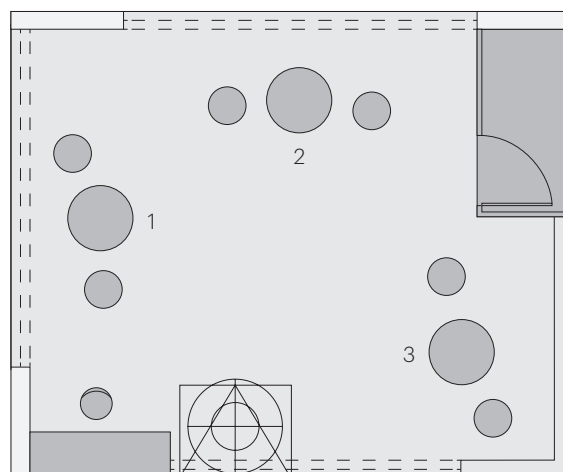

Eurecat

Eurecat works in several lines related to blockchain technology:

- Cybersecurity issues relevant to this technology (analysis of weaknesses, threats and attacks).
- Analysis and development of quantum and post-quantum algorithms to be applied in Blockchain.
- Support to companies interested in blockchain-based innovation, by integrating this technology into their services, internal processes, production processes, etc. in an efficient and secure way.

Eurecat is an active member of BECON (Blockchain Ecosystem Network) Catalan chapter.

Government of Catalonia V200
Stand 2

Company
Eurecat

Contact
Mario Reyes
mario.reyes@eurecat.org
+34 671 908 228

www.eurecat.org

eurecat!
Centre Tecnològic de Catalunya



UbiCrypto

UbiCrypto conducts blockchain and cryptocurrency workshops, teaches a successful investment strategy and sends signals of when to buy and sell specific cryptos.

It also helps entrepreneurs to create their token or ICO, and corporations to adapt their business to blockchain.

Government of Catalonia V200
Stand 3

Company
UbiCrypto

Contact
Adrià Aguadé
adria.aguade@gmail.com
+34 697 364 023

www.ubicrypto.com



Ubiquat

At Ubiquat, we engage new forms of social economy and interactive government. By deploying hybrid platforms that integrate blockchain and centralized solutions, we provide the best approach for the B2B, B2C, G2B and G2C interactions.

Our experience includes the Grama, first local currency in Europe with public expenditures channeled in, and VilaWatt, the first Spain's currency for energy transition. Our next projects include Barcelona among other cities and regions of Spain and Europe.

Ubiquat offers bring key solutions, providing technology, legal framework, model design, result metrics and guidance through the project, assisting the whole road to the new digital ecosystem.

Government of Catalonia V200
Stand 1

Company
Ubiquat

Contact
Jaume Catarineu
j.catarineu@ubiquat.com
+34 678 892 739

www.ubiquat.com



